



## TWO STAGE HEAVY OIL BURNERS

### ► PRESS N SERIES

► PRESS 30 N	85/171 ÷ 342 kW
► PRESS 45 N	114/205 ÷ 513 kW
► PRESS 60 N	171/342 ÷ 684 kW
► PRESS 100 N	285/490 ÷ 1140 kW



The PRESS N series of burners covers a firing range from 85 to 1140 kW and they have been designed for use in civil installations of average dimensions, like building areas and large apartment groups or for use in industrial applications, like small or medium plants. Operation is two stage; a servomotor adjust automatically air damper opening, to obtain the right air delivery on both stage.

The combustion head, that can be set on the basis of required output, allows optimal performance ensuring good combustion and reducing fuel consumption and is available in two different length to be selected on the basis of specific application requirements. In basic version the burners are supplied for use with heavy oil 7°E viscosity, but they can be supplied with higher viscosity oil with a specific heaters kit.

Simplified maintenance is achieved by the slide bar system, which allows easy access to all of the essential components of the combustion head.

# TECHNICAL DATA

Model		▼ PRESS 30 N	▼ PRESS 45 N	▼ PRESS 60 N	▼ PRESS 100 N
Burner operation mode		Two stage			
Modulation ratio at max. output		2 : 1			
Servomotor	type	LKS 210			
	run time	s			
Heat output	kW	85/171÷342	114/205÷513	171/342÷684	285/490÷1140
	Mcal/h	73/147÷294	98/176÷441	147/294÷588	245/421÷980
	kg/h	7,5/15÷30	10/18÷45	15/30÷60	25/43÷100
Working temperature		°C min./max. 0/40			
NCV Heavy Oil	kWh/kg	11,4			
	kcal/kg	9800			
Viscosity at 50°C		50 (150 with heavy oil kit)		50 (500 with heavy oil kit)	
Pump	type	D67			
	delivery	kg/h	65 (20 bar)	110 (20 bar)	200 (20 bar)
Atomised pressure		bar 20			
Fuel temperature		Max. °C 140			
Fuel pre-heater		YES			
Fan		type Centrifugal with forward blades			
Air temperature		Max. °C 60			
Electrical supply		Ph/Hz/V 1/50/230~(±10%)	3N/50/400~(+10%)	3/50/230~(+10%)△	
Auxiliary electrical supply		Ph/Hz/V 1/50/230~(±10%)			
Control box		type RMO			
Total electrical power		kW 3,5	3,7	5,5	9,0
Auxiliary electrical power		kW 0,33	0,45	0,5	0,5
Heaters electrical power		kW 2,8	2,8	4,2	7
Protection level		IP 40			
Pump motor electrical power		kW --			
Rated pump motor current		A --			
Pump motor start up current		A --			
Pump motor protection level		IP --			
Fan motor electrical power		kW 0,37	0,45	0,75	1,5
Rated fan motor current		A 2,9	1,9-1,1	2,9-1,7	6-3,5
Fan motor start current		A 9,5	9,5-5,5	14-8	28-16
Fan motor protection level		IP 54			
Ignition transformer		type --			
		V1 - V2 230 V - 2x6,5 kV			
		I1 - I2 2 A - 35 mA			
Operation		Intermittent (at least one stop every 24 h)			
Sound pressure		dB (A) 75	78	81	83
Sound power		W --			
CO emission		mg/kWh < 50			
Grade of smoke indicator		N° Bacharach < 5			
C <sub>x</sub> H <sub>y</sub> emission		mg/kWh --			
NO <sub>x</sub> emission level		mg/kWh < 650			
Directive		73/23 - 89/336 - 98/37- 92/42 EEC			
Conforming to		EN 267			
Certification		--			

## Reference conditions:

Ambient temperature: 20°C  
 Barometric pressure: 1013.5 mbar  
 Altitude: 100 meters a.s.l.  
 Noise measured at a distance of 1 meter.

Since the Company is constantly engaged in the production improvement, the aesthetic and dimensional features, the technical data, the equipment and the accessories can be changed.

This document contains confidential and proprietary information of RIELLO S.p.A. Unless authorised, this information shall not be divulged, nor duplicated in whole or in part.



## FIRING RATES

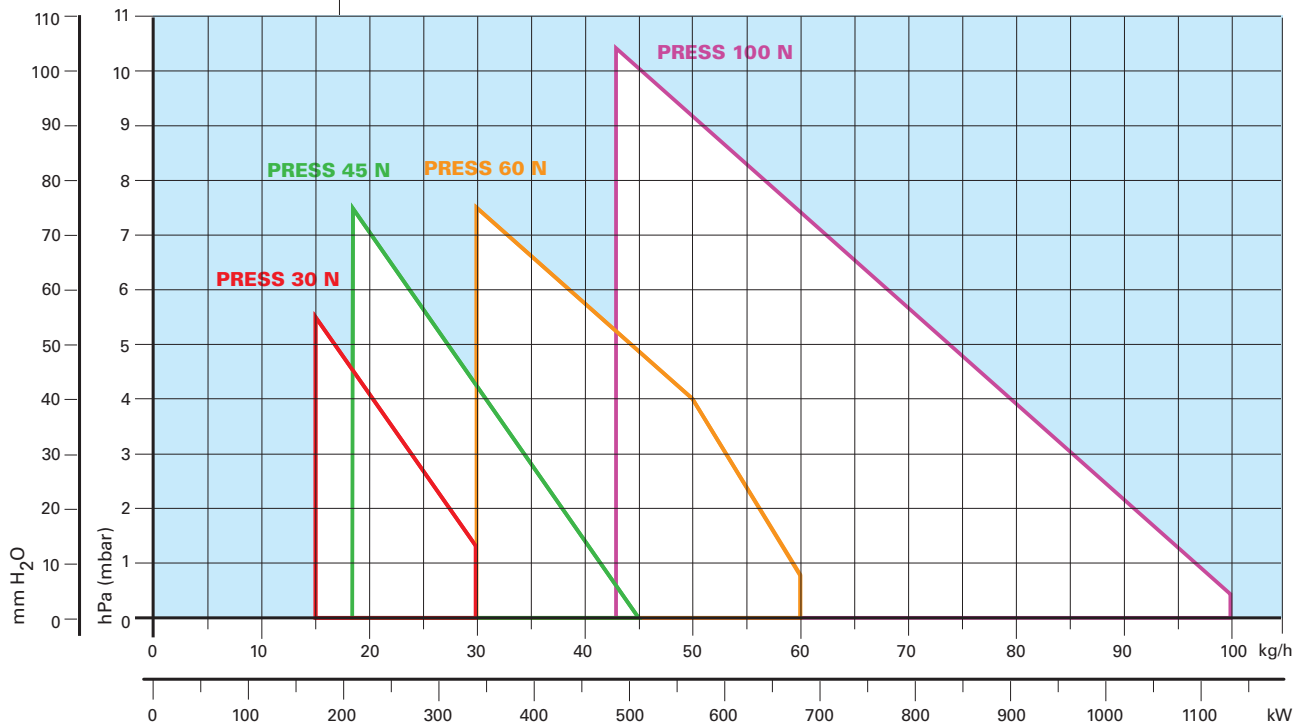

Useful working field for choosing the burner

**Test conditions conforming to EN 267:**

Temperature: 20°C  
Pressure: 1013.5 mbar  
Altitude: 100 m a.s.l.



## FUEL SUPPLY

### HYDRAULIC CIRCUITS

The burners are fitted with an oil pre-heater, a check valve and two delivery valves along the oil line from the pump to the nozzles.

The oil pre-heater is equipped with a filter with sheath for thermometer, a setting thermostat to adjust the oil temperature and two safety thermostats to control the max. and min. oil temperature.

A control device, on the basis of required output, regulates oil delivery valves opening, allowing oil passage through the valves and the nozzles whose opening is regulated from a needle valve.

An oil delivery gauge allow to control the delivery pressure. A specific version PRESS N/ECO is available for operation with low sulphur fuels; these models are made up of separated oil pump motor at 1400 rpm and double filter between pump and nozzle.

For heavy oil preheating, a special kit could be used; equipped with electrical heaters, it permits the use of PRESS N and PRESS N/ECO burners with fuel oil of max. viscosity 23°E at 50°C (PRESS 30 N - 45 N) or 50°E at 50°C (PRESS 60 N - 100 N), (see Burner Accessory paragraph).



Example of the hydraulic circuit on PRESS N

### PRESS 30 N - 45 N - 60 N - 100 N

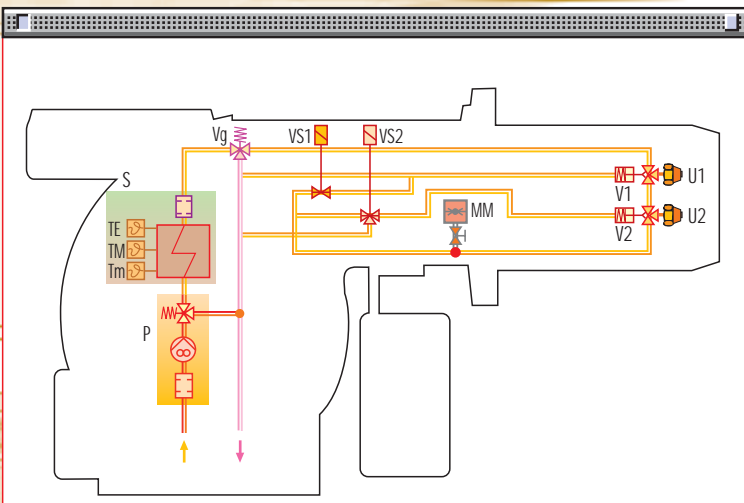

P	Pump with filter, heater and pressure regulator on the output circuit
S	Oil preheater with filter, maximum, minimum and regulation thermostat
TE	Oil temperature regulator
TM	Max oil temperature switch
Tm	Min oil temperature switch
Vg	Check valve
VS1	1st stage delivery valve
VS2	2nd stage delivery valve
V1	1st stage nozzle needle valve
V2	2nd stage nozzle needle valve
U1	1st stage nozzle
U2	2nd stage nozzle
MM	Oil delivery gauge



## DIMENSIONING OF THE FUEL SUPPLY LINES

The fuel feed must be completed with the safety devices required by the local norms.

### IMPORTANT NOTES

- The oil could easily flow through the pipes if those are properly sized, protected and heated (by electricity, steam or hot water)
- In order to limit gas or steam production the oil pressure into the gas separator shall be set in function of the supply temperature, see instructions manual.
- The forwarding pump should have at least a double capacity than that one of the burner. For several burners supplied through the same ring supply line, the forwarding pump should have a capacity of approximatively 30% more than the sum of the single burners outputs.

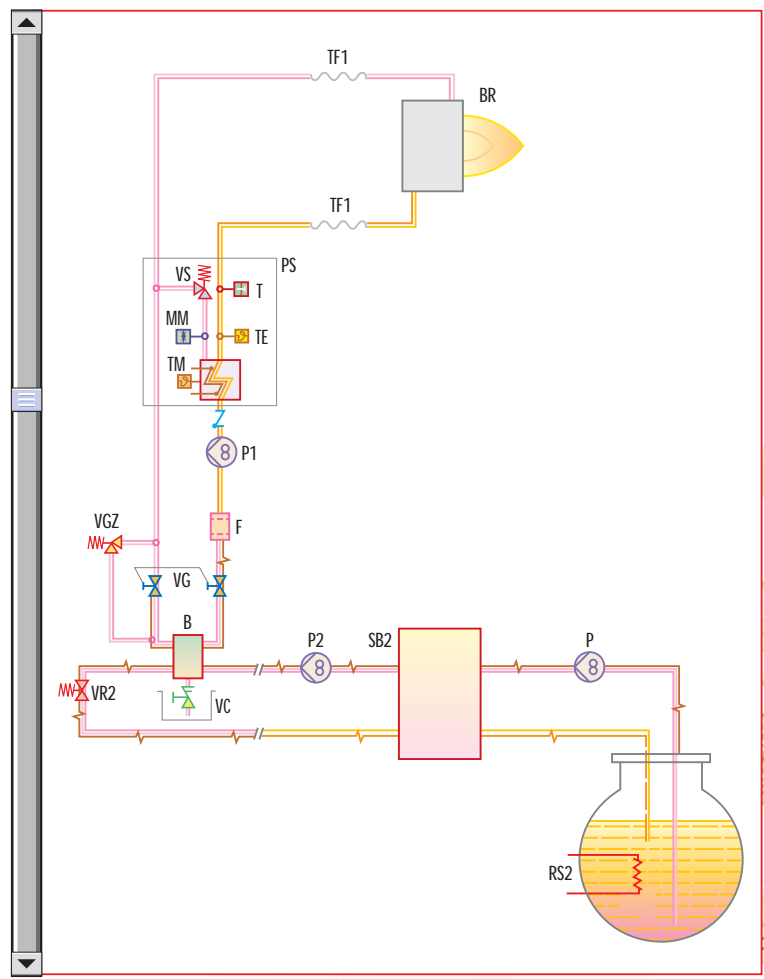

RS2	Tank heater
P	Double pumping unit with filter and heater on transfer ring
SB2	Service tank
P2	Double pumping unit with filter and heater on main ring
VR2	Oil valve – main ring
B	Gas separator bottle
VGZ	Safety valve – burner circuit
P1	Pump with heater – burner circuit
PS	Electrical preheater
VS	Preheater safety valve
BR	Burner
TF1	Flexible oil line
T	Thermometer
TM	Max oil temperature switch
TE	Temperature switch regulation
MM	Oil delivery gauge
VC	Vent valve
F	Oil filter





## VENTILATION

The ventilation circuit of PRESS N burners is inserted in an extremely compact structure and it is provided with a forward blades centrifugal fan, which guarantees high pressure levels at the required air deliveries and permits installation flexibility. A servomotor adjust automatically air damper opening, to obtain the right air delivery on both stage.

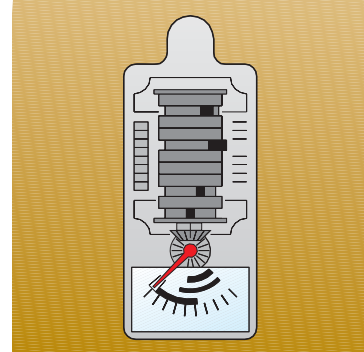

Example of the servomotor for air regulation on PRESS N burners



## COMBUSTION HEAD

Two different lengths of the combustion head can be chosen for the various models of the PRESS N series of burners.

The choice depends on the thickness of the front panel and the type of the boiler.

Depending on the type of heat generator, it is necessary to check the correct head penetration into the combustion chamber.

The internal position of the combustion head can easily be adjusted: refer to the burner instruction manual for the complete procedure.

The following diagram shows the flame dimensions in relation to the burner output. The length and diameter shown in the diagram below should be employed preliminary check: it is required a more careful investigation if combustion chamber dimensions are much different from the above reported values.

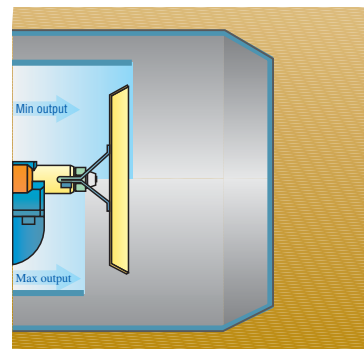

Example of a PRESS N burner combustion head

### Dimensions of the flame

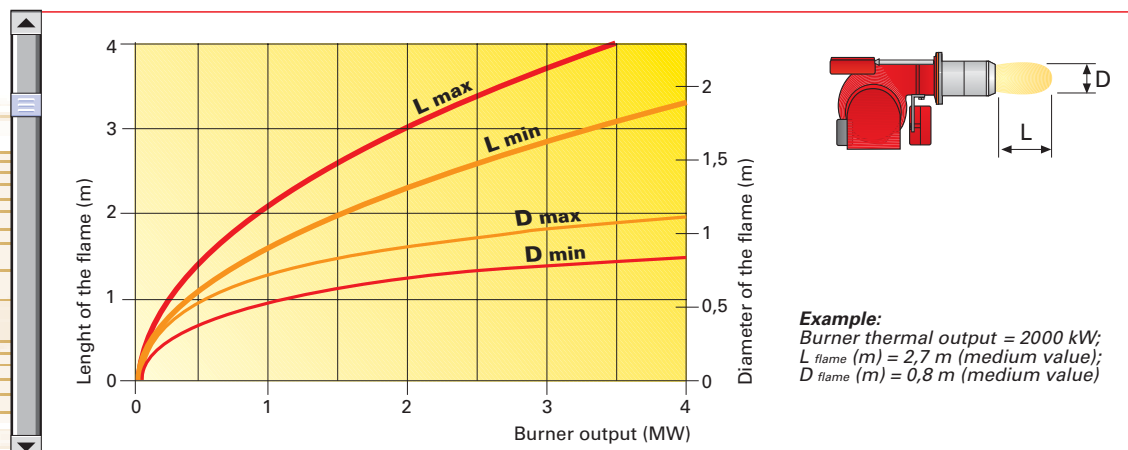

# ADJUSTMENT



## BURNER OPERATION MODE

### Two stage operation

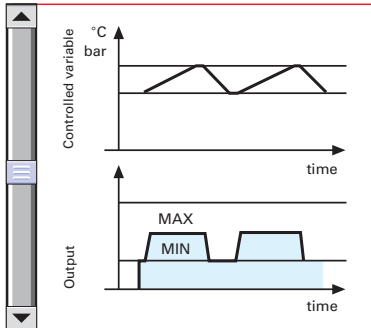

Picture A

With two stage operation, the PRESS N burners can follow the temperature load requested by the system. A modulation ratio of 2:1 is reached, thanks to the "two nozzles" technique; the air is adapted to the servomotor positions. On "two stage" operation, the burner gradually adjusts output to the requested level, by varying between the two pre-set levels (see picture A).

All PRESS N series burners are fitted with a new microprocessor control panel for the supervision during intermittent operation.

For helping the commissioning and maintenance work, there are two main elements:



The lock-out reset button is the central **operating element** for resetting the burner control and for activating / deactivating the diagnostic functions.



The multi-color LED is the central **indication element** for visual diagnosis and interface diagnosis.

Both elements are located under the transparent cover of lock-out reset button, as showed below.

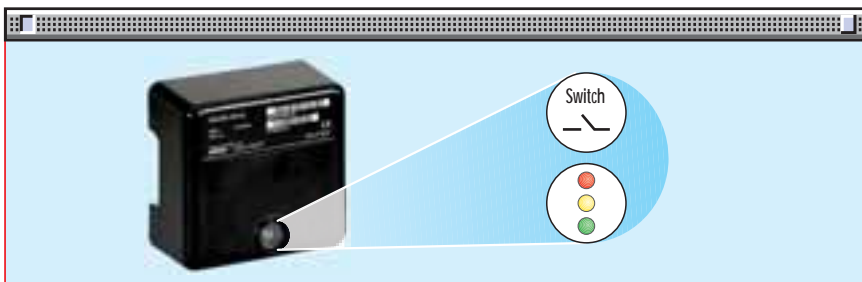

There are two diagnostic choices, for indication of operation and diagnosis of fault cause:

### - visual diagnosis :

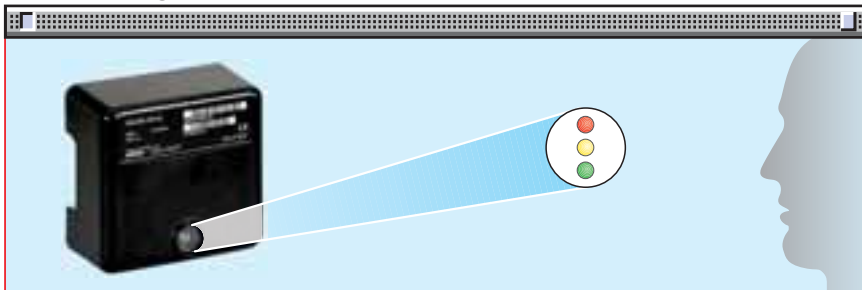

### - interface diagnosis :

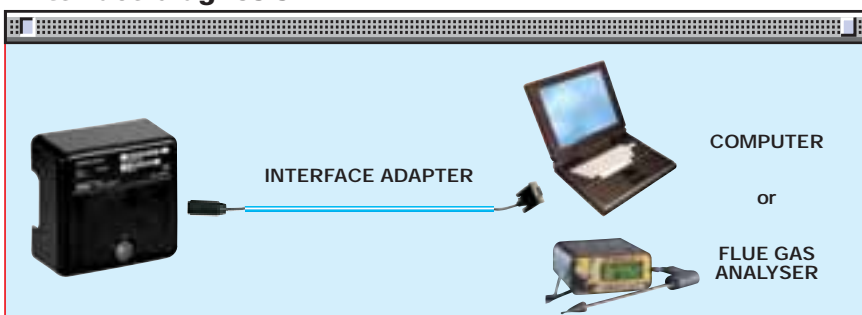

by the interface adapter and a PC with dedicated software or by a predisposed flue gas analyzer (see paragraph accessories).





### Indication of operation :

In normal operation, the various statuses are indicated in the form of colour codes according to the table below.

The interface diagnosis (with adapter) can be activated by pressing the lock-out button for > 3 seconds.

Color code table	
Operation statuses	Color code table
Stand-by	○ ○ ○ ○ ○ ○ ○ ○
Pre-purging	☀ ☀ ☀ ☀ ☀ ☀ ☀ ☀
Ignition phase	☀ ○ ☀ ○ ☀ ○ ☀ ○
Flame OK	☀ ☀ ☀ ☀ ☀ ☀ ☀ ☀
Poor flame	☀ ○ ☀ ○ ☀ ○ ☀ ○
Undervoltage, built-in fuse	☀ ☀ ☀ ☀ ☀ ☀ ☀ ☀
Fault, alarm	☀ ☀ ☀ ☀ ☀ ☀ ☀ ☀
Extraneous light	☀ ☀ ☀ ☀ ☀ ☀ ☀ ☀

○ LED off

### Diagnosis of fault causes :

After lock-out has occurred, the red signal lamp is steady on. In this status, the visual fault diagnosis according to the error code table can be activated by pressing the lock-out reset button for > 3 seconds. The interface diagnosis (with adapter) can be activated by pressing again the lock-out button for > 3 seconds.

The blinkers of red LED are a signal with this sequence :

(e.g. signal with n° 3 blinks – faulty air pressure monitor)



Error code table	
Possible cause of fault	Blink code
No establishment of flame at the end of safety time : - faulty or soiled fuel valves - faulty or soiled flame detector - poor adjustment of burner, no fuel - faulty ignition equipment	☀ ☀
Faulty air pressure monitor	☀ ☀ ☀
Extraneous light or simulation of flame on burner start up	☀ ☀ ☀ ☀
Loss of flame during operation : - faulty or soiled fuel valves - faulty or soiled flame detector - poor adjustment of burner	☀ ☀ ☀ ☀ ☀ ☀ ☀ ☀
Wiring error or internal fault	☀ ☀ ☀ ☀ ☀ ☀ ☀ ☀ ☀ ☀

## START UP CYCLE

PRESS 30 N - 45 N - 60 N - 100 N

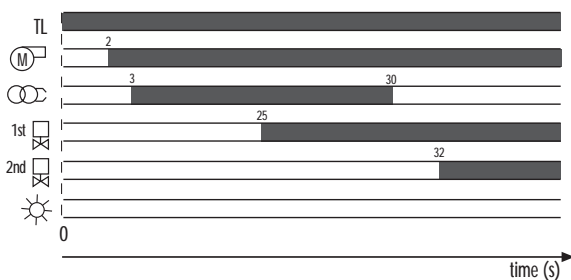

- 0s Control device TL closes.
- 2s The motor starts turning. Pre-purging phase begins.
- 3s The transformer are supplied.
- 25s 1<sup>st</sup> delivery valve opens and the fuel is ignited.
- 30s The ignition transformer switches off.
- 32s Output can be increased.



# WIRING DIAGRAMS



Electrical connections must be made by qualified and skilled personnel, according to the local norms.

## TWO STAGE OPERATION

### PRESS 30 N - single-phase electrical connection

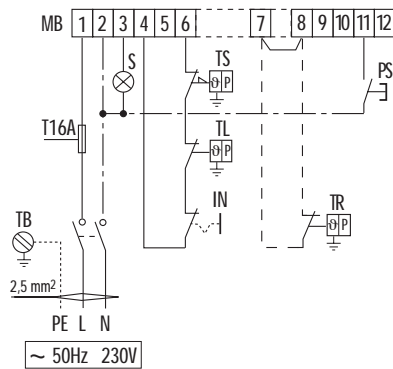

- MB** - Burner terminal board
- TS** - Safety thermostat
- TL** - Threshold thermostat
- TR** - High/low flame setting thermostat
- S** - External lock-out signal
- TB** - Burner ground (earth) connection
- IN** - Manual switch
- T16A** - 16A fuse
- PS** - Lock-out reset button

### PRESS 45 N - three-phase electrical connection

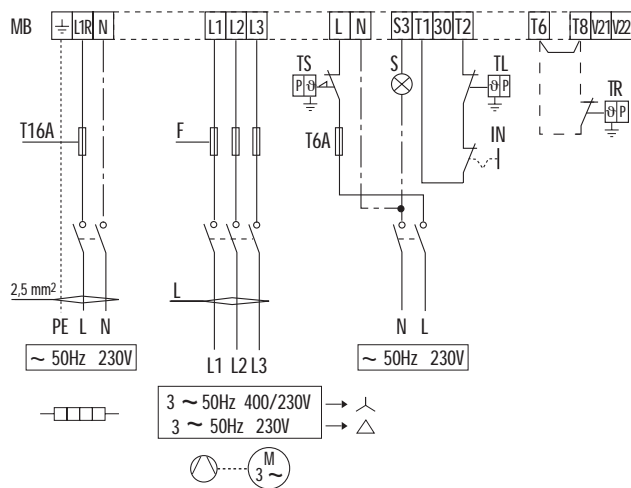

- MB** - Burner terminal board
- TS** - Safety thermostat
- TL** - Threshold thermostat
- TR** - High/low flame setting thermostat
- S** - External lock-out signal
- F** - Fuse (see table A)
- TB** - Burner ground (earth) connection
- IN** - Manual switch
- T6A** - 6A fuse
- T16A** - 16A fuse
- F** - Fuse (see table A)
- PS** - Lock-out reset button
- L** - Lead section (see table A)



### PRESS 60 N - 100 N - three-phase electrical connection

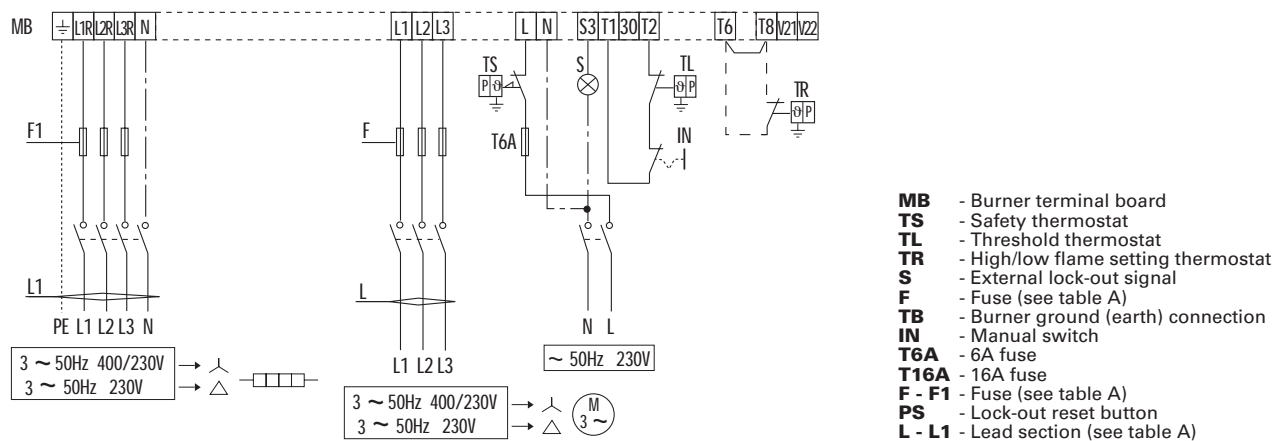

The following table shows the supply lead sections and the type of fuse to be used.

Model	▼ PRESS 30 N		▼ PRESS 45 N		▼ PRESS 60 N		▼ PRESS 100 N	
	230V	400V	230V	400V	230V	400V	230V	400V
F A	T16	T10	T6	T10	T6	T16	T10	
L mm <sup>2</sup>	2,5	1,5	1,5	1,5	1,5	1,5	1,5	1,5
F1 A	-	-	-	T16	T10	T25	T16	
L1 mm <sup>2</sup>	-	-	-	4	2,5	6	4	

Table A

# EMISSIONS

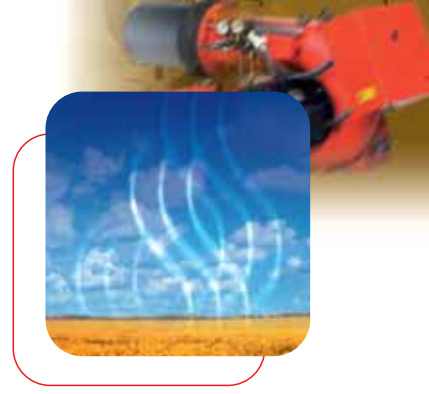
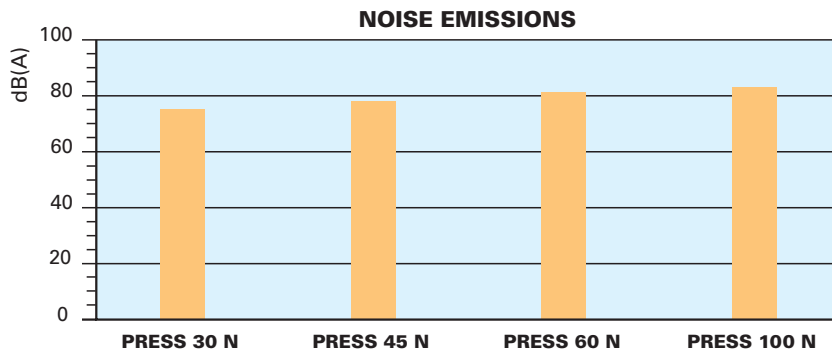
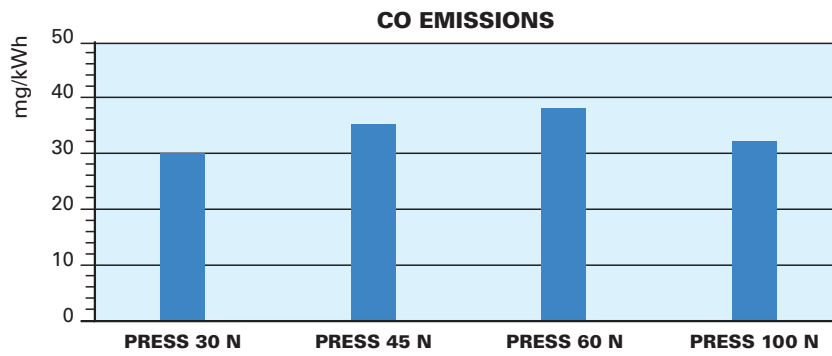
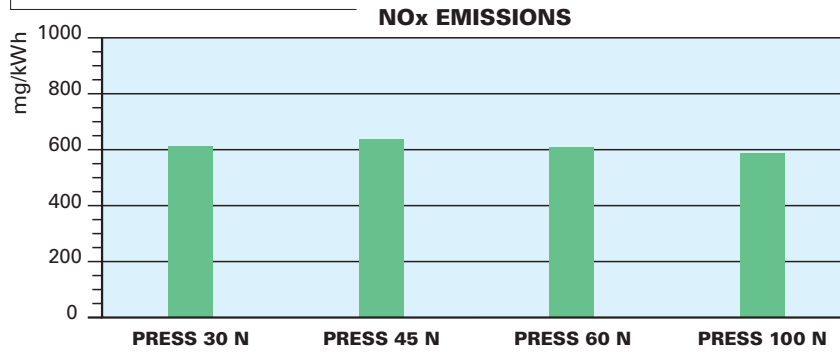

The emission data has been measured in the various models at maximum output, according to EN 267 standard.





## OVERALL DIMENSIONS (mm)

### BURNERS

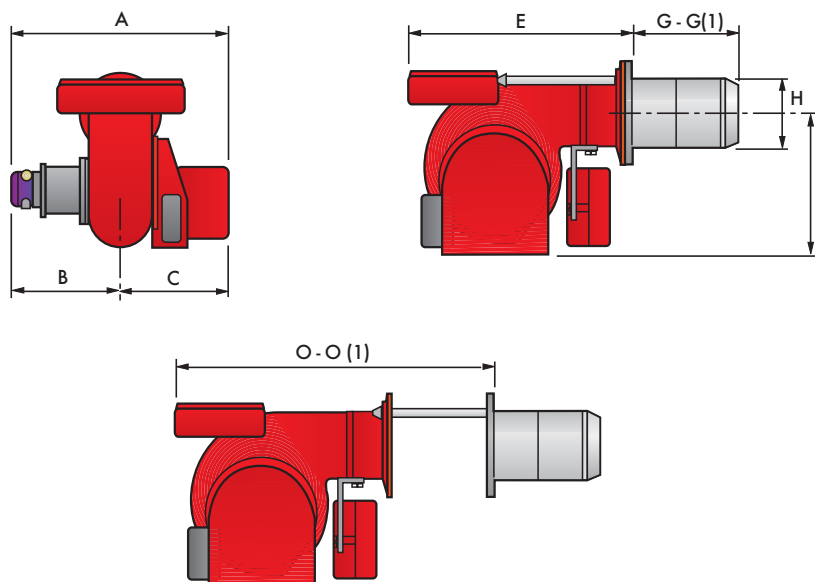

Model	A	B	C	E	G - G(1)	H	I	O - O(1)
▶ <b>PRESS 30 N</b>	625	335	290	625	185 - 320	161	305	905 - 1080
▶ <b>PRESS 45 N</b>	625	335	290	625	235 - 370	161	305	925 - 1100
▶ <b>PRESS 60 N</b>	625	335	290	660	245 - 400	172	335	940 - 1115
▶ <b>PRESS 100 N</b>	625	335	290	710	250 - 410	195	370	1010 - 1195

(1) Length with extended combustion head

### BURNER - BOILER MOUNTING FLANGE

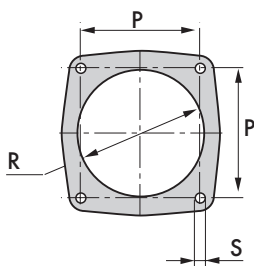

Model	P	R	S
▶ <b>PRESS 30 N</b>	160	170	M 10
▶ <b>PRESS 45 N</b>	160	170	M 10
▶ <b>PRESS 60 N</b>	160	180	M 10
▶ <b>PRESS 100 N</b>	195	205	M 12

### PACKAGING

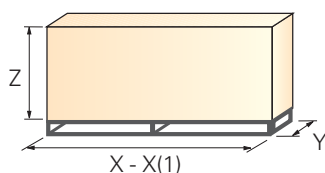

Model	X - X(1)	Y	Z	kg
▶ <b>PRESS 30 N</b>	880 - 1015	690	522	84
▶ <b>PRESS 45 N</b>	880 - 1015	690	522	84
▶ <b>PRESS 60 N</b>	925 - 1095	760	552	87
▶ <b>PRESS 100 N</b>	985 - 1145	790	552	104

(1) Length with extended combustion head

## INSTALLATION DESCRIPTION

Installation, start up and maintenance must be carried out by qualified and skilled personnel. All operations must be performed in accordance with the technical handbook supplied with the burner.



### BURNER SETTING

- ▶ All the burners have slide bars, for easier installation and maintenance.
- ▶ After drilling the boilerplate, using the supplied gasket as a template, dismantle the blast tube from the burner and fix it to the boiler.
- ▶ Adjust the combustion head.
- ▶ Refit the burner casing to the slide bars.
- ▶ Install the nozzles, choosing these on the basis of the maximum boiler output and following the diagrams included in the burner instruction handbook.
- ▶ Check the position of the electrodes.
- ▶ Close the burner, sliding it up to the flange, keeping it slightly raised to avoid the flame stability disk rubbing against the blast tube.

### HYDRAULIC AND ELECTRICAL CONNECTIONS AND START-UP

- ▶ The burners are supplied for connection to two pipes fuel supply system.
- ▶ Connect the ends of the flexible pipes to the suction and return pipework using the supplied nipples.
- ▶ Make the electrical connections to the burner following the wiring diagrams included in the instruction handbook.
- ▶ Prime the pump by turning the motor.
- ▶ On start up, check:
  - Pressure pump (to max. and min.)
  - Combustion quality, in terms of unburned substances and excess air.



## BURNER ACCESSORIES

### Nozzles

The nozzles must be ordered separately. The following table shows the features and codes on the basis of the maximum required output.



Nozzle type F80 PL 45°			
Burner	Rated delivery (kg/h) at 20 bar	GPH	Nozzle code
PRESS 30 N - 45 N	10,6	2	3043121
PRESS 30 N - 45 N	11,9	2,25	3043131
PRESS 30 N - 45 N - 60 N	13,2	2,5	3043141
PRESS 45 N - 60 N	15,8	3	3043151
PRESS 45 N - 60 N - 100 N	18,5	3,5	3043161
PRESS 45 N - 60 N - 100 N	21,1	4	3043171
PRESS 60 N - 100 N	23,7	4,5	3043181
PRESS 60 N - 100 N	26,4	5	3043191
PRESS 100 N	29	5,5	3043201
PRESS 100 N	31,7	6	3043211
PRESS 100 N	34,3	6,5	3043221
PRESS 100 N	36,9	7	3043231
PRESS 100 N	39,6	7,5	3043241
PRESS 100 N	44,8	8,5	3043261

Nozzle type F80 PL 60°			
Burner	Rated delivery (kg/h) at 20 bar	GPH	Nozzle code
PRESS 30 N	6,6	1,25	3041092
PRESS 30 N - 45 N	7,9	1,5	3041102
PRESS 30 N - 45 N	9,2	1,75	3041112
PRESS 30 N - 45 N	10,6	2	3043122
PRESS 30 N - 45 N	11,9	2,25	3043132
PRESS 30 N - 45 N - 60 N	13,2	2,5	3043142
PRESS 45 N - 60 N	15,8	3	3043152
PRESS 45 N - 60 N - 100 N	18,5	3,5	3043162
PRESS 45 N - 60 N - 100 N	21,1	4	3043172
PRESS 60 N - 100 N	23,7	4,5	3043182
PRESS 60 N - 100 N	26,4	5	3043192
PRESS 100 N	29	5,5	3043202
PRESS 100 N	31,7	6	3043212
PRESS 100 N	34,3	6,5	3043222
PRESS 100 N	36,9	7	3043232
PRESS 100 N	39,6	7,5	3043242
PRESS 100 N	44,8	8,5	3043262



### Spacer kit

If burner head penetration into the combustion chamber needs reducing, varying thickness spacers are available, as given in the following table:

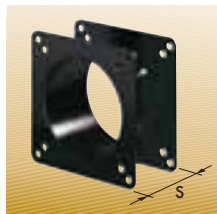

Spacer kit		
Burner	Spacer thickness S (mm)	Kit code
PRESS 30 N - 45 N - 60 N	142	<b>3000755</b>
PRESS 100 N	142	<b>3000802</b>

### Sound proofing box

If noise emissions need reducing, sound proofing hoods are available, as given in the following table.



Sound proofing box			
Burner	Box type	Average noise reduction [dB(A)](*)	Box code
PRESS 30 N - 45 N - 60 N - 100 N	C1/3	10	<b>3010403</b>

(\*) according to EN 15036-1 standard

### Selfcleaning filter

For cleaning heavy oil from dirty particles and impurities, it is equipped with a thermostatic heater for oil with 50°E viscosity at 50°C.



Selfcleaning filter	
Type	Filter code
ø=1 50°E – 50°C	<b>3000790</b>

Thermostatic heater	
Type	Heater code
Thermostatic heater 80W	<b>3010059</b>

### Heavy oil kit

Equipped with electrical heaters, it permits the employment of PRESS N burners with fuel oil of max. viscosity 23°E at 50°C (PRESS 30 N - 45 N) and 50°E at 50°C (PRESS 60 N - 100 N).

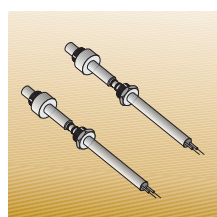

Heavy oil kit	
Burner	Kit code
PRESS 30 N - 45 N	<b>3000797</b>
PRESS 60 N - 100 N	<b>3010013</b>



## Cartridge filter

For cleaning heavy oil from dirty particles and impurities, it is equipped with a cartridge system for oil with 7°E viscosity at 50°C.



Type	Filter code
Cartridge 7°E – 50°C	<b>3005209</b>

Type	Heaters code
Thermo - resistance up to 30° E - 50°	<b>3010050</b>

## Thermostats

Thermostats allow heavy oil temperature control and regulation during burner operation. They are available in electronic and maximum versions.

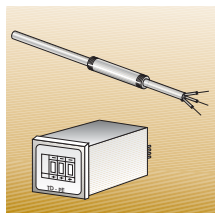

Thermostats		
Burner	Thermostat	Kit code
PRESS 30 N - 45 N - 60 N - 100 N	Electronic	<b>3000799</b>
PRESS 30 N - 45 N - 60 N - 100 N	Maximum	<b>3000800</b>
PRESS 30 N - 45 N - 60 N - 100 N	Kit electronic	<b>3010173</b>

## PC interface kit

To connect the flame control panel to a personal computer for the transmission of operation, fault signals and detailed service information, an interface adapter with PC software are available.



Interface adapter	
Burner	Kit code
PRESS 30 N - 45 N - 60 N - 100 N	<b>3002719</b>



## SPECIFICATION

A specific index guides your choice of burner from the various models available in the PRESS N series. Below there is a clear and detailed specification description of the product.



### DESIGNATION OF SERIES

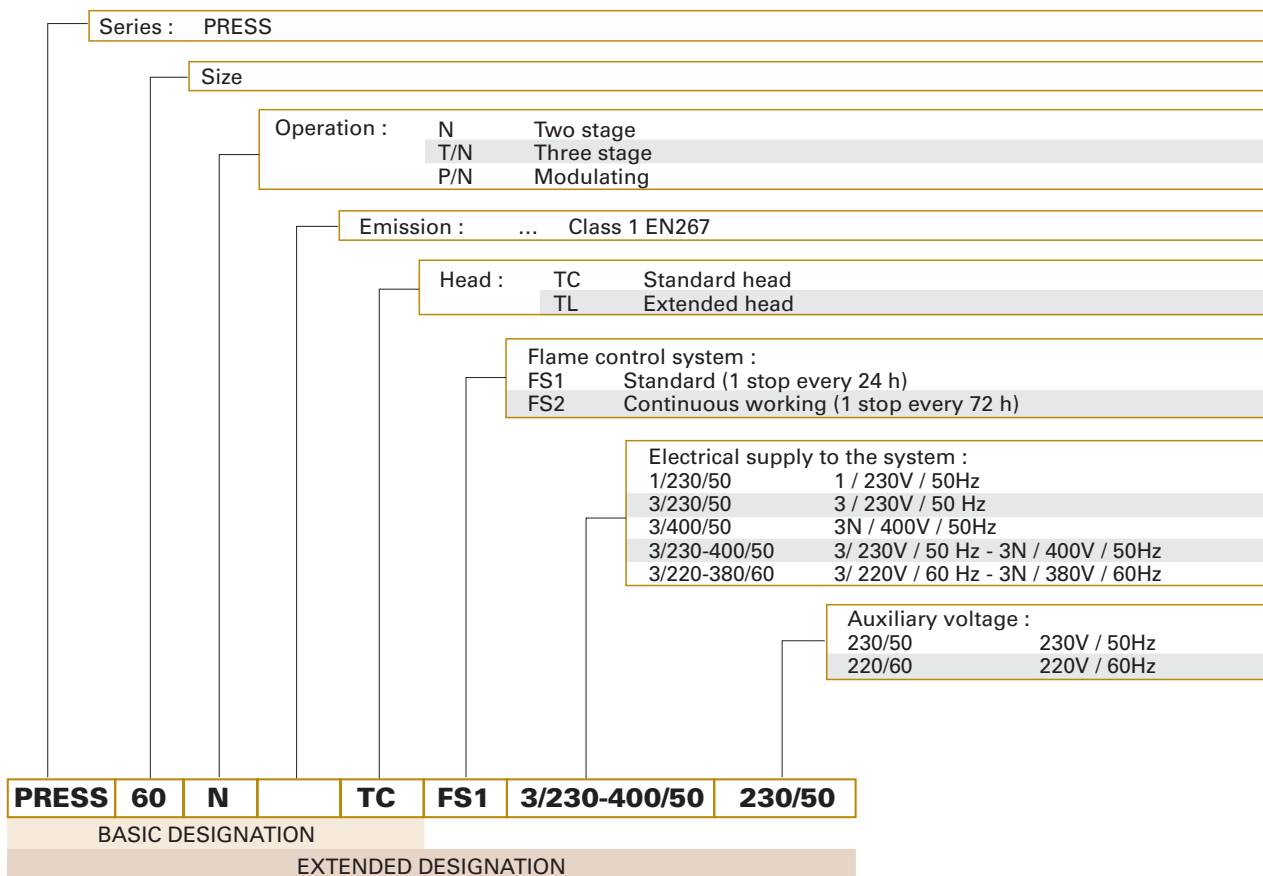

### AVAILABLE BURNER MODELS

PRESS 30 N	TC	FS1	1/230/50	230/50	PRESS 60 N	TC	FS1	3/230-400/50	230/50
PRESS 30 N	TL	FS1	1/230/50	230/50	PRESS 60 N	TL	FS1	3/230-400/50	230/50
PRESS 30 N	TC	FS1	3/220-380/60	220/60	PRESS 60 N	TC	FS1	3/220-380/60	220/60
PRESS 30 N	TL	FS1	3/220-380/60	220/60	PRESS 60 N	TL	FS1	3/220-380/60	220/60
PRESS 45 N	TC	FS1	3/230-400/50	230/50	PRESS 100 N	TC	FS1	3/230-400/50	230/50
PRESS 45 N	TL	FS1	3/230-400/50	230/50	PRESS 100 N	TL	FS1	3/230-400/50	230/50
PRESS 45 N	TC	FS1	3/220-380/60	220/60	PRESS 100 N	TC	FS1	3/220-380/60	220/60
PRESS 45 N	TL	FS1	3/220-380/60	220/60	PRESS 100 N	TL	FS1	3/220-380/60	220/60

Other models are available on request.



## ▶ PRODUCT SPECIFICATION

### **Burner:**

Monoblock forced draught heavy oil burner with two stage operation, fully automatic, made up of:

- Air suction circuit lined with sound-proofing material
- Fan with forward curve blades, high performance pressure levels
- Air damper for air setting controlled by a servomotor
- Starting motor at 2800 rpm, three-phase 400V with neutral, 50Hz (single-phase, 230V and 50Hz for the 30 N model)
- Combustion head, that can be set on the basis of required output, fitted with:
  - stainless steel end cone, resistant to corrosion and high temperatures
  - ignition electrodes
  - flame stability disk
- Gears pump for high pressure fuel supply, fitted with:
  - filter
  - pressure regulator
  - connections for installing a pressure gauge and vacuumeter
- Oil pre-heater equipped with a filter with sheath for thermometer, a setting thermostat and two safety thermostats
- Valve unit with an check valve and two delivery oil valves
- Oil delivery gauge
- Photocell for flame detection
- Microprocessor-based flame control panel, with diagnostic functions
- Slide bars for easier installation and maintenance
- Protection filter against radio interference
- IP 44 electric protection level.

### **Conforming to:**

- 89/336/EEC directive (electromagnetic compatibility)
- 73/23/EEC directive (low voltage)
- 92/42/EEC directive (performance)
- 98/37/EEC directive (machinery)
- EN 267 (liquid fuel burners).

### **Standard equipment:**

- 2 flexible pipes for connection to the oil supply network
- 2 gaskets for the flexible pipes
- 2 nipples for connection to the pump
- 4 screws for fixing the burner flange to the boiler
- 1 thermal screen
- 2 nozzles
- 2 slide bar extensions (for the extended head models)
- Instruction handbook for installation, use and maintenance
- Spare parts catalogue.

### **Available accessories to be ordered separately:**

- Nozzles
- Spacer kit
- Sound-proofing box
- Self cleaning filter
- Heavy oil kit
- Cartridge filter
- Thermostat
- PC interface kit.

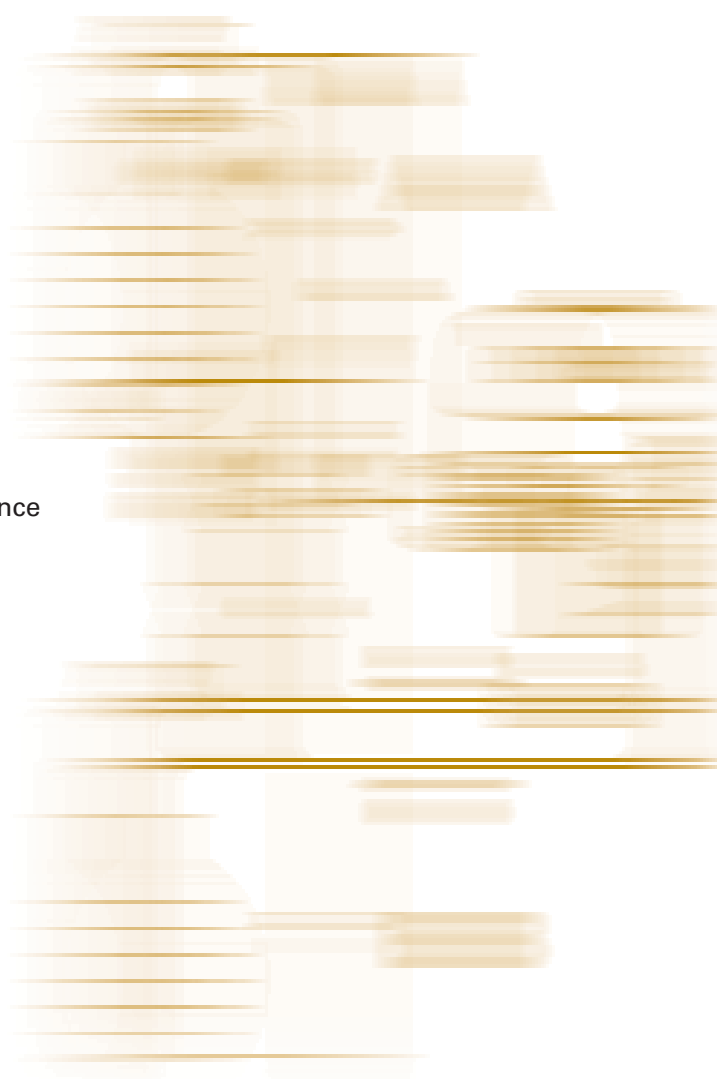





RIELLO S.p.A. - Via Ing. Pilade Riello, 5 - 37045 Legnago (VR) Italy  
Tel. ++39.0442630111 - Fax ++39.044221980

Internet: <http://www.rielloburners.com> - E-mail: [info@rielloburners.com](mailto:info@rielloburners.com)

Since the Company is constantly engaged in the production improvement, the aesthetic and dimensional features, the technical data, the equipment and the accessories can be changed.  
This document contains confidential and proprietary information of RIELLO S.p.A.  
Unless authorised, this information shall not be divulged, nor duplicated in whole or in part.

